

Article number: 2310304881ESD

Description: E+G Antistatic base for levelling elements
LV.A-80-24-M24x198-ESD-C

Measures

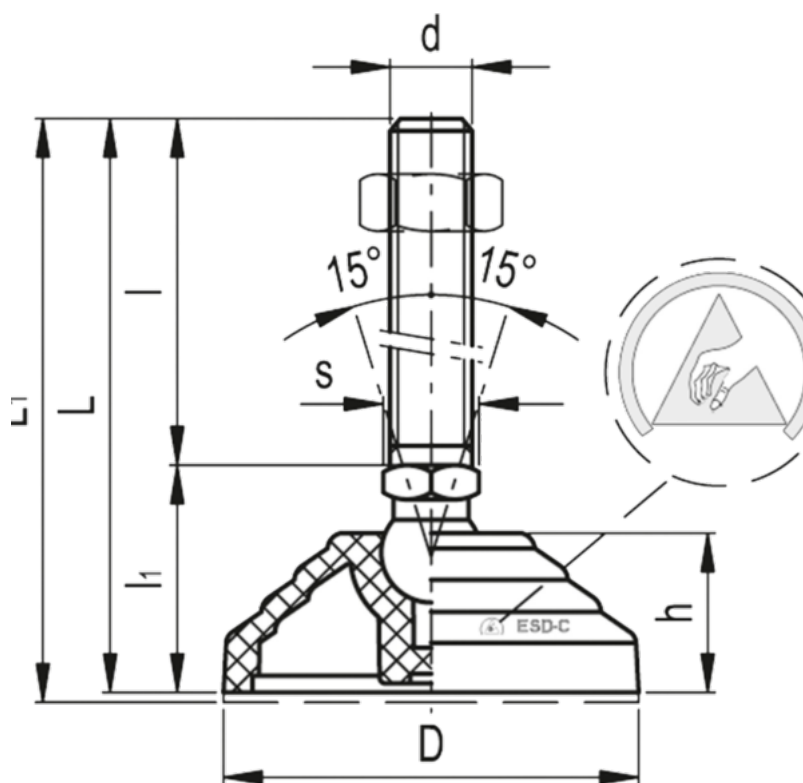

Articulation = 24
D = 80
d = M24
h = 24
l = -
l1 = -
L = 241
Max load = 18000

s = 24
Weight in (g) = 734